

Miniaturization of Buck-Boost DC-DC Converter with Fast P Control

Yudai Furukawa[†], Ippei Sugimoto[†], Fujio Kurokawa[†], Haruhi Eto^{*}, Tsuyoshi Higuchi[†] and Ilhami Colak^{**}

[†]Graduate school of Engineering, Nagasaki University
Nagasaki, Japan
bb52215203@cc.nagasaki-u.ac.jp

^{*}Graduate school of Engineering, Nagasaki Institute of Applied Science
Nagasaki, Japan
haruhi-eto@awa.bbiq.jp

^{**}Faculty of Engineering and Architecture, Gelisim University
Istanbul Turkey
icolak@gelisim.edu.tr

Abstract—This paper presents a consideration about miniaturization of buck-boost dc-dc converter with the fast P control. From frequency characteristics, it is identified that fast P control method is useful to suppression of output capacitance and circuit miniaturization.

Keywords-component; dc-dc converter; digital control; Fast P control; circuit miniaturization

I. INTRODUCTION

In late years, utilizing renewable energy attracts attention because the increase of energy demands is expected. However Due to using nature energy such as force of wind and solar light, the input voltage of system greatly fluctuates. Moreover, reduction of the number of electronic circuits is important for downsizing such as a mobile phone. The buck-boost type dc-dc converter that can realize step-up and step-down operation by one circuit is useful for these problems [1]-[4].

As for those apparatuses, functions are required: cooperating on environment, using information with networks. These functions can be easily realized by using digital technology. So in the control of switching power supplies, in order to utilize more efficiently, the energy management with digital control instead of the conventional analog control has attracted attention. As the advantage of digital control, having a high tolerance to the deterioration and temperature changes due to aging, other cooperation with the monitoring and control design changes and other system is easy, miniaturization of the control circuit due to advanced research and development of processor has been mentioned. However, applying the digital control switching power supply, a problem occurs that increases the response time by the delay time of the control. When delay time increases, transient response and stability of the system is getting worse. In order to reduce the effect of delay time, fast P control dividing PID control to the two part and assigning fast sampling frequency for P control have been proposed [5]-[10]. This paper presents a comparison the conventional PID control

This paper presents a comparison the conventional PID control and fast P control about frequency characteristics of the

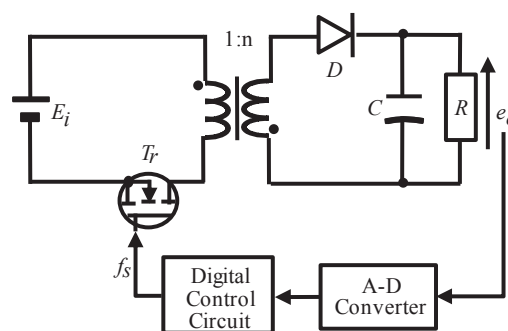

Figure 1. Digital controlled dc-dc converter

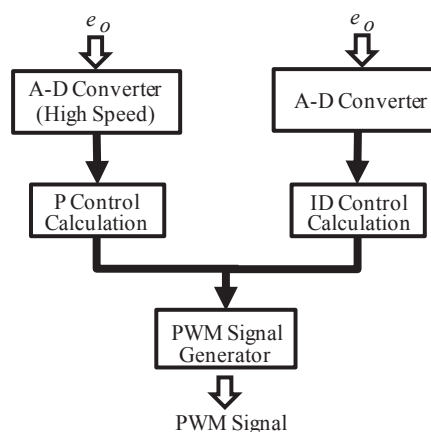

Figure 2. Diagram of A-D converter and digital control circuit.

buck-boost type dc-dc converter system. Furthermore, an advantage of the fast P control suppression of output capacitance and circuit miniaturization is suggested. So far there was the examination fast P control has been applied to buck type dc-dc converter. First, this paper shows the operation principle and circuit structure of fast P control method And then, an examination using bode diagram from a loop transfer function of the system has presented.

II. OPERATION PRINCIPLE

Figure 1 shows schematic of buck-boost type dc-dc converter with the digital control circuit. E_i is the input voltage and e_o is the output voltage. T_r is the main switch, D is the flywheel diode, C is the output capacitor, and R is the load, The switching frequency F_s is equal to 100 KHz. In this schematic, the output voltage e_o is detected and inputted to the A-D converter.

The control system diagram of fast P control method is as shown Fig. 2. In the fast P control method, the PID control calculation is divided two parts, P control calculation and ID control calculation. Each control calculation circuit uses A-D converter having different performance. The P control part uses the A-D converter with high sampling frequency. On the other hand ID control part uses the A-D converter having sampling frequency equal to switching frequency. These operations are processed in parallel, and operation results are inputted into the PWM signal generator. Figs. 3 and 4 show the sampling period of each control method. This chapter describes samplings for each control.

A. Conventional PID control

Figure 3 shows the timing chart of the conventional PID control. The white rhombic symbol indicates the valid sampling point for the PID control. In the conventional PID control method, sampling and calculation are done once during one switching period. The transfer function of the conventional PID control method $H_{PID}(s)$ is described as follows:

$$H_{PID}(s) = \frac{\left(H_P + \frac{H_I}{s} + sH_D \right) e^{-s\tau_1}}{1 + s\tau_3}, \quad (1)$$

where H_P is the proportional gain, H_I is the integral gain and H_D is the differential gain. τ_1 is the delay time of the conventional PID control. Moreover, each gain is described by

$$H_P = \frac{K_P A G_{AD}}{N T_S}, \quad (2)$$

$$H_I = \frac{K_I A G_{AD}}{N T_S T_S}, \quad (3)$$

$$H_D = \frac{K_D A G_{AD} T_S}{N T_S}, \quad (4)$$

where T_S is the switching period, $N T_S$ is the resolution of DPWM, K_P , K_I and K_D are coefficients of each control P, I and D.

B. Fast P control

Figure 4 illustrates the timing chart of the fast P control method. The white and black circle symbol indicates the sampling point for the P control. Then the white square symbol

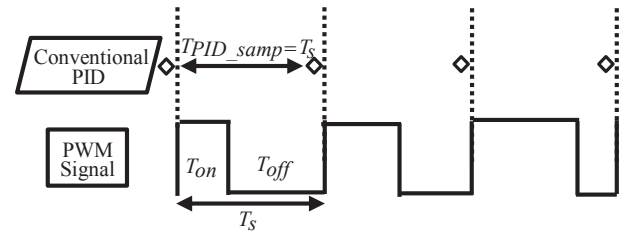

Figure 3. Sampling method of the conventional PID control method.

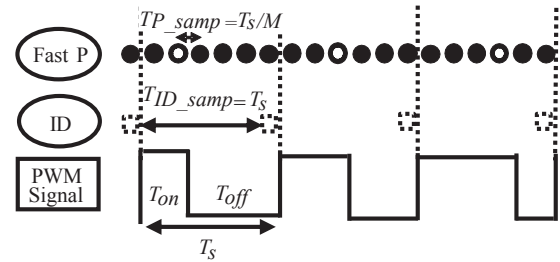

Figure 4. Sampling method of the Fast P control method.

indicates the sampling point for the ID control. White square symbol is the valid sampling point and black is invalid. While the sampling period for ID control in the fast P control method is equal to switching period. Fast P control method is able to reduce the influence of delay time of the digital control because of the newer calculation is reflected to switching control. The transfer function of the fast P control method $H_{FP}(s)$ is described as follows:

$$H_{FP}(s) = \frac{H_{FP} e^{-s\tau_2} + \left(\frac{H_I}{s} + sH_D \right) e^{-s\tau_1}}{1 + s\tau_3}, \quad (5)$$

τ_2 is the delay time of P control of fast P control method. H_{FP} is the proportional gain as follows:

$$H_{FP} = \frac{K_{FP} A G_{AD}}{N T_S}, \quad (6)$$

where K_{FP} is the coefficient of P control.

III. FREQUENCY CHARACTERISTICS

In this chapter, the examination using a bode diagram from a loop transfer function of system is presented. A bode diagram has been described by MATLAB. Figure 5 shows the equivalent circuit schematic of Fig. 1. The ideal transformer can be approximated as reactive coil. A loop transfer function of the digital controlled dc-dc converter system $G_L(s)$ is as follows:

$$G_L(s) = E_i H(s) G(s), \quad (7)$$

where $G(s)$ is transfer function of buck-boost type dc-dc converter and $H(s)$ is the transfer function of each control.

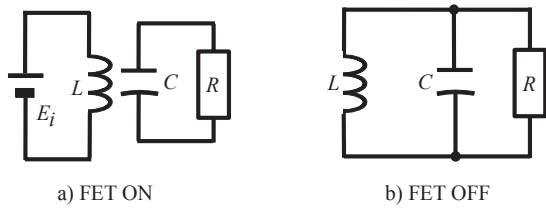

Figure 5. Equivalent circuit of buck-boost dc-dc converter.

$$G(s) = \frac{D'^2 R}{s^2 LCR + s(L + rRC) + D'^2 R + r} \quad (8)$$

In equation, r is internal resistance of circuit. D and D' are ratio at on time and off time of switch to switching period.

$H(s)$ is obtained as follows. In the conventional PID control method;

$$H_{conv}(s) = \frac{H_{PID}(s)}{1 + s\tau_3}, \quad (9)$$

On the other hand fast P control method;

$$H_{pro}(s) = \frac{H_{FP}(s)}{1 + s\tau_3}, \quad (10)$$

where τ_3 is the time constant of the anti-alias filter. In these function, delay time elements have been approximation as follows:

$$e^{-s\tau} \approx \frac{1}{1 + s\tau}. \quad (11)$$

Then a loop transfer function of each control method system as follows:

$$G_{Loop_conv}(s) = E_i H_{conv}(s) \frac{D'^2 R}{s^2 LCR + s(L + rRC) + D'^2 R + r}, \quad (12)$$

$$G_{Loop_pro}(s) = E_i H_{pro}(s) \frac{D'^2 R}{s^2 LCR + s(L + rRC) + D'^2 R + r}. \quad (13)$$

The frequency characteristics as bode diagram are shown in Figs. 5 and 6. There is each line when output capacitance of dc-dc converter is varied 100 μ F to 1600 μ F. Circuit parameters are summarized in Table 1. Bode plot form of two control methods are similar and the cut-off frequency is almost equal when each value of the output capacitance is same. Table 2 shows the gain and phase margin of each control method from the bode plot of figs. 6 and 7. When same output capacitance, gain margin and phase margin values of the fast P control method are larger than these values of the conventional PID control method. Moreover about phase margin, a difference increases with the output capacitance becomes small.

TABLE I. CIRCUIT PARAMETERS

L	250 (μ H)	NT_S	2000
R	10 (Ω)	τ_1	10 (μ s)
r	0.3 (Ω)	τ_2	1 (μ s)
D'	0.5	τ_3	4.7 (μ s)
E_i	10 (V)	H_P	0.205
T_S	10 (μ s)	H_{FP}	0.205
A	0.125	τ	500
G_{AD}	818.8 (1/V)	τ_D	0.25
n	1		

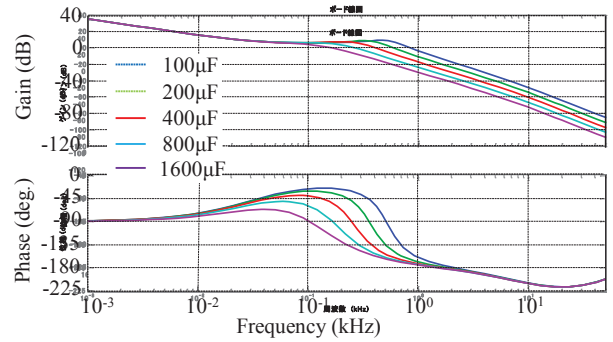

Figure 6. Bode plot of the conventional PID control method..

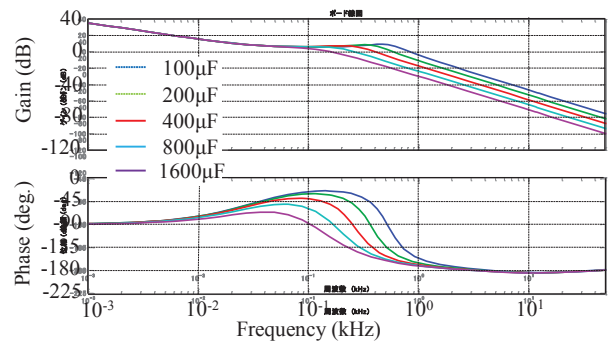

Figure 7. Bode plot of the fast P control method.

TABLE II. GAIN MARGIN AND PHASE MARGIN

Gain margin(dB)	100 μ F	200 μ F	400 μ F	800 μ F	1600 μ F
Conventional PID	18.5	21.9	26.3	31.4	36.9
Fast P	31.3	34.5	38.7	43.7	49.2

Phase margin(deg)	100 μ F	200 μ F	400 μ F	800 μ F	1600 μ F
Conventional PID	28.9	32.3	39.3	50.5	64.4
Fast P	31.6	34.2	40.7	51.4	65.0

IV. CONCLUSION

This paper presents a consideration about a buck-boost type dc-dc converter's stability when two control methods are applied. From these results, the frequency characteristics of the system are improved by applying the fast P control method even if the output capacitance decreases. The fast P control

method has an advantage that suppression of the output capacitor. In other words, the fast P control method is useful to miniaturization buck-boost type dc-dc converter.

REFERENCES

- [1] Sahin M.E and Bokumas H.I, "Small signal analyses and hardware implementation of a buck-boost converter for renewable energy applications," in Proc of IEEE ICRERA, pp. 330-335, 2013.
- [2] Montecucco A and Knox A.R, "Maximum Power Point Tracking Converter Based on the Open-Circuit Voltage Method for Thermoelectric Generators," IEEE Trans on Power Electronics, Vol.30, pp.828-839, 2014
- [3] M. Sechilariu, B. Wang and F. Locment: "Building integrated photovoltaic system with energy storage and smart grid communication," IEEE Trans. on Industrial Electronics, vol. 60, no. 4, pp. 1607-1618, 2013.
- [4] R. Kurte, K. I. Kai Wang, D. Thrimawithana, U. K. Madawala and Z. Salcic, "An intelligent hybrid communication system for a distributed renewable energy management," in Proc. 39th Annual Conference of the IEEE Industrial Electronics Society, pp. 3323-3328, 2013.
- [5] D. Maksimovic, R. Zane and R. Erickson, "Impact of digital control in power electronics," in Proc of IEEE ISPSD, pp. 13-22, 2004.
- [6] L. Guo, J. Y. Hung, and R. M. Nelms, "PID controller modifications to improve steady state performance of digital controllers for buck and boost converters," in Proc. IEEE APEC, vol.1, pp. 381-388, 2002.
- [7] H. Peng, A. Prodic, E. Alarcon and D. Maksimovic : "Modeling of quantization effects in digitally controlled dc-dc converters," IEEE Trans. on Power Electronics, vol. 22, no. 1, pp. 208-215, 2007
- [8] E. T. Moore and T. G. Wilson: "Basic considerations for dc to dc conversion networks," IEEE Trans. on Magnetics, vol. MAG-2, no.3, pp. 620-624, Sept. 1996
- [9] F. Kurokawa, R. Yoshida and Y. Furukawa, "Digital Fast P Slow ID control dc-dc converter in different resolutions," Trans. IEEE Industry Applications, vol.51, no.1, pp. 353-361, 2015.
- [10] Fujio Kurokawa and Yudai Furukawa, "High performance digital control switching power supply," proc. of International Power Electronics and Motion Control Conference and Exposition, pp. 1378-1383, 2014.

renewable energy management," in Proc. 39th Annual Conference of the